

B M R PLA 34

Power quality analyzer class S

User and service manual



version 1.8

Content

1. Introduction.....	3	9.1.7. Voltage transformers.....	14
2. Safety instructions.....	3	9.1.8. Current transformers.....	14
3. Packaging content.....	3	9.1.9. Rogowski coil measuring range.....	14
4. Device description.....	4	9.1.10. Averaging.....	14
4.1. Front panel.....	4	9.1.11. Energy.....	15
4.2. Rear panel.....	4	9.2. Communication settings.....	15
5. Measured parameters.....	5	9.2.1. Ethernet.....	15
6. Installation.....	5	9.2.2. Web-server.....	15
7. Connection.....	6	9.2.3. FTP server.....	16
7.1. Grounding conductor.....	6	9.2.4. Modbus TCP.....	16
7.2. Supply voltage.....	6	9.2.5. TCP converter.....	16
7.3. Voltage measuring inputs.....	6	9.2.6. RS485.....	16
7.4. Current measuring inputs.....	7	9.3. NTP server, Time zone.....	17
7.5. Current measuring inputs for PLA34RG.....	7	9.4. Email.....	17
7.6. RS485.....	8	9.5. Transient.....	18
7.7. Ethernet.....	8	9.6. Events.....	20
7.7.1. Connection of PLA34 into LAN.....	8	9.6.1. Voltage dip detection.....	20
7.7.2. Connection of PLA34 to WiFi.....	9	9.6.2. Voltage swell detection.....	20
7.7.3. Connection of PLA34 to LAN with NAT server.....	9	9.6.3. RVC.....	21
7.8. USB.....	10	9.7. Inputs/Outputs.....	22
7.9. Digital inputs / outputs.....	10	9.8. Alarms.....	22
8. Device settings.....	11	9.9. Display settings.....	24
8.1. Menu P1.....	11	9.10. Data storage.....	24
8.2. Menu P2.....	11	9.11. Memory settings.....	26
9. Advanced setting from PMS software.....	11	9.12. About.....	26
9.1. Main parameters.....	11	10. Operation.....	26
9.1.1. Network type.....	12	10.1. Screens structure.....	27
9.1.2. Nominal voltage.....	14	10.2. Max, Min and AVG values.....	28
9.1.3. Nominal current.....	14	10.3. Output signalization.....	29
9.1.4. System frequency.....	14	11. Web interface.....	29
9.1.5. Flicker.....	14	12. Firmware update.....	29
9.1.6. Ripple control.....	14	13. Technical features.....	30

1. Introduction

Power quality analyser PLA34 is designed for measurement of voltage network quality in LV and MV according the norm EN 50160.

Technology of the measurement is performed according the norm “IEC 61000-4-30: Electromagnetic compatibility (EMC) – Part 4-30: Testing and measurement techniques – Power quality measurement methods”, measurement class “Class A”.

Power quality analyser PLA34 is designed for measurement and monitoring of electrical parameters in 2, 3 and 4 conductor networks and in TN and TT grids.

2. Safety instructions

Instrument comply the standard EN 61010-1: Safety requirements for electrical equipment for measurement, control, and laboratory use.

- Installation of the instrument can be done by qualified and authorised person only.
- Instrument should not be installed in the environment with increased humidity and close to explosive gases.
- Use the instrument in accordance instructions written in the user manual.
- Before the disconnection of CT measuring circuits assure that terminals of CT are short circuited.
- Installation and connection changes can be done without supply voltage only.
- Do not apply supply, measuring voltage and current higher that allowed.

3. Packaging content

- Power quality analyser PLA34
- Mounting holders with screws – 2 pieces
- User manual
- Test report

4. Device description

4.1. Front panel

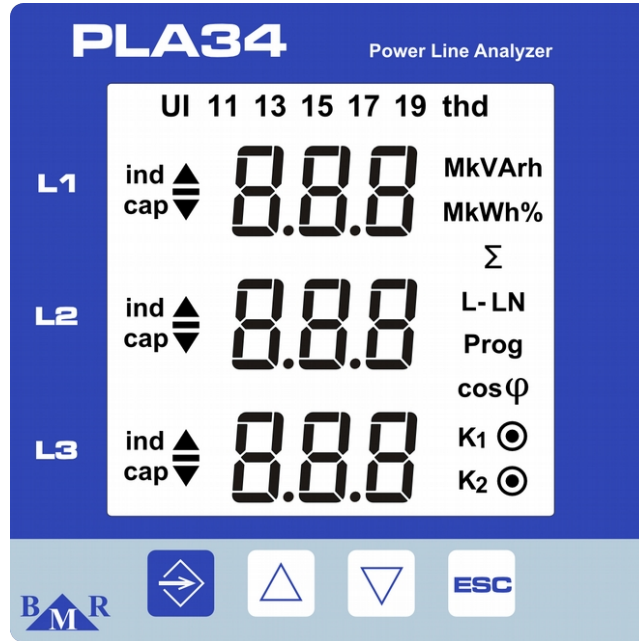

– key for entering menu, parameters, average, max / min values



– ESC key for canceling or return



– cursor key for moving up in menu and value increase



– cursor key for moving down in menu and value decrease

4.2. Rear panel

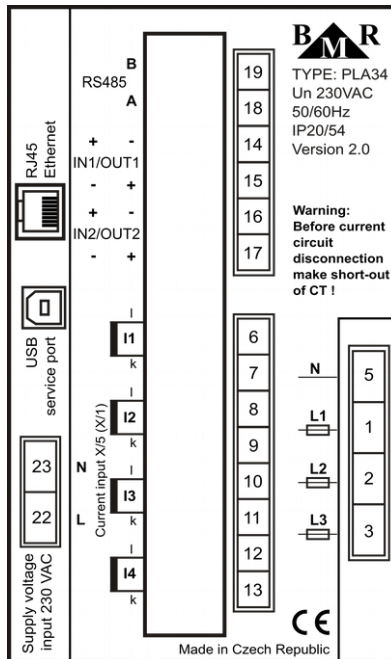

5. Measured parameters

Power quality analyser PLA34 is designed for measurement and monitoring of electrical parameters in 2, 3 and 4 conductor networks and in TN and TT grids. PLA34 power quality analyser architecture is based on fast 32 bits RISC microprocessor which provides high computing power to assure the device being fully according the norm IEC 61000-4-30 class S.

Parameter	L1	L2	L3	N	L1-L2	L2-L3	L3-L1	ΣL1-L3	Max	Min	AVG	Measuring range	Displayed range	Accuracy
Phase voltage	•	•	•						•	•	•	2 ... 600 V	0 ... 1 MV	±0.2 %
Line voltage					•	•	•		•	•	•	4 ... 1000 V	0 ... 1 MV	±0.2 %
Frequency	•								•	•	•	40 ... 70 Hz	40 ... 70 Hz	10 mHz
Current	•	•	•	•				•	•	•	•	0.001 ... 6 A	0 ... 1 MA	±0.2 %
cosφ	•	•	•						•	•	•	0.01 L ... 0.01 C	0.01L ... 0.01C	±1 %
Power factor	•	•	•						•	•	•	0.01 L ... 0.01 C	0.01L ... 0.01C	±1 %
THDU L-N	•	•	•						•	•	•	0 ... 99.9 %	0 ... 99.9 %	±5 %
THDU L-L					•	•	•		•	•	•	0 ... 99.9 %	0 ... 99.9 %	±5 %
THDI	•	•	•	•					•	•	•	0 ... 99.9 %	0 ... 99.9 %	±5 %
Harmonics of voltage	•	•	•						•	•	•	0 ... 99.9 %	0 ... 99.9 %	class 1
Group of interharmonics U	•	•	•									0 ... 99.9 %	0 ... 99.9 %	class 1
Group of harmonics U	•	•	•									0 ... 99.9 %	0 ... 99.9 %	class 1
Harmonics P	•	•	•									0 ... 99.9 %	0 ... 99.9 %	class 1
Harmonics Q	•	•	•									0 ... 99.9 %	0 ... 99.9 %	class 1
Harmonics I	•	•	•	•					•	•	•	0 ... 99.9 %	0 ... 99.9 %	class 1
Group of interharmonics I	•	•	•	•								0 ... 99.9 %	0 ... 99.9 %	class 1
Group of harmonics I	•	•	•	•								0 ... 99.9 %	0 ... 99.9 %	class 1
Short-term flicker	•	•	•						•	•	•	0 ... 20.0 Pst	0.4 ... 20.0 Pst	class A
Long-term flicker	•	•	•						•	•	•	0 ... 20.0 Plt	0.4 ... 20.0 Plt	class A
Under-voltage	•	•	•		•	•	•		•	•	•	0 ... 100 %	0 ... 100 %	±0.2 %
Over-voltage	•	•	•		•	•	•		•	•	•	0 ... 100 %	0 ... 100 %	±0.2 %
Unbalance U									•	•	•	0 ... 100 %	0 ... 100 %	±0.15 %
Neutral point displacement									•	•	•	10 ... 600 V	0 ... 1 MV	±0.2 %
K-factor	•	•	•											
Unbalance I									•	•	•			±0.5 %
Transients	•	•	•											25 μs
Events	•	•	•											10 ms
Ripple control signal	•	•	•		•	•	•		•	•	•			
Active power	•	•	•					•	•	•	•	0 ... 10.8 kW	0 ... 999 GW	±0.4 %
Reactive power	•	•	•					•	•	•	•	0 ... 10.8 kvar	0 ... 999 Gvar	±0.4 %
Apparent power	•	•	•					•	•	•	•	0 ... 10.8 kVA	0 ... 999 GVA	±0.4 %
Distortion power	•	•	•					•	•	•	•			±0.5 %
Active energy +/-	•	•	•					•				0 ... 999 GWh	0 ... 999 GVh	class 0.5
Reactive ind. energy +/-	•	•	•					•				0 ... 999 Gvarh	0 ... 999 Gvarh	class 0.5*
Reactive cap. Energies +/-	•	•	•					•				0 ... 999 Gvarh	0 ... 999 Gvarh	class 0.5*

* fundamental

Measured and displayed parameters

6. Installation

PLA34 is prepared for wall mounting in the fixed switch boards. In order to assure well ventilation, the PLA34 has to be installed vertically. There has to be empty space at least 50 mm at the top and bottom and 20 mm at the sides.

PLA34 is fixed into switchboard wall by two clips that are placed on the device at the bottom and top.

7. Connection

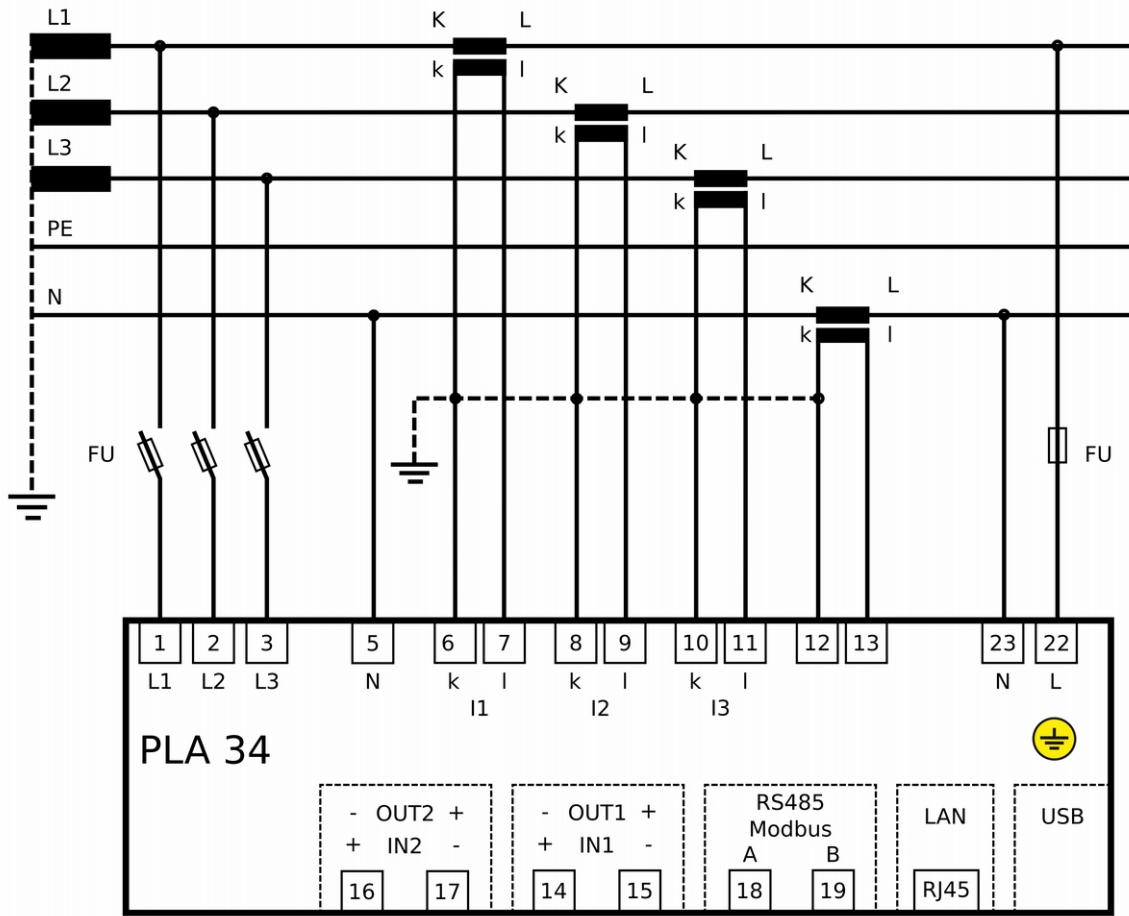

Device connection at TN-C network

7.1. Grounding conductor

The grounding terminal has to be connected as a first terminal. Grounding terminal is realized by threaded pole with 3 mm diameter and it is marked by symbol .

7.2. Supply voltage

Supply voltage is required to operate the PLA34. The type and level of the necessary supply voltage is written on the back label. Before applying the supply voltage, make sure that the voltage level and system frequency match the details on the label. The connection cables for the supply voltage has to be connected using a fuse. Use a fuse (6 A type C).

7.3. Voltage measuring inputs

Instrument has four voltage measuring inputs with input impedance 4 MΩ suitable for measurement according the category CATIII 600 V.

Each voltage measuring input have to be connected via circuit breaker or switch and fuse (10 A characteristic C) which are placed close to the device.

Important

Supply voltage has to be from the same grid as measuring voltages



Notice

PLA34 is not designed for measuring of DC voltage!

PLA34 is not designed for usage in SELV grids!



Notice

If the voltage measuring inputs are connected over the voltage measuring transformers the power of measuring transformer power must be at appropriate level. Voltage measuring inputs have 5 mW self consumption. Recommendation from measuring transformer producers is to have loaded voltage measuring transformer on 70% of maximum power for the best accuracy.

7.4. Current measuring inputs

Instrument has four current measuring inputs for indirect measurement via current measuring transformers, either $\cdot/5A$ or $\cdot/1A$ ratio. CT ratio is freely adjustable from an instrument or via PC software.

Warning

Current inputs maximum permanent capability is 8.5 A.

Important

Before opening the current circuit be sure that measuring terminals of current transformer are connected together.



Notice

PLA34 is not designed for DC current measurement!

7.5. Current measuring inputs for PLA34RG

PLA34RG is the variant of PLA34 power quality analyser with current measuring inputs constructed by flexible Rogowski coils. PLA34RG supports coils with 100 mV / 1 kA / 50 Hz. Rogowski coils are connected to instrument via signal wire + (white colour), signal wire - (blue colour) and shielding. Shielding is connected to the terminal labelled S.

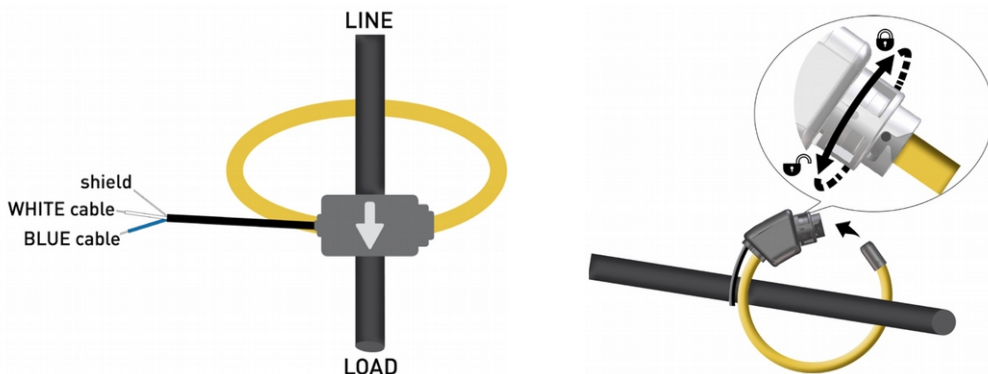

Inside the PLA34RG there is digital integrator for adjusting the measuring range of current input. For proper current measurement the measuring range has to be defined by DIP switch on the rear side of the PLA34RG. The combination of particular current measuring ranges is shown on the picture.

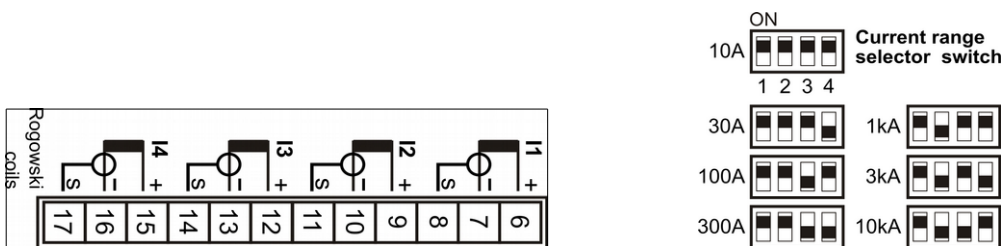

Note

The configuration of the current measuring range has to be set also in the instrument settings in the menu **P_1** or via PMS software. See the chapter 8.1 or 9.1.9

Important

Current measuring range changes has to be always made at opened Rogowski coils.

7.6. RS485

The PLA34 has built-in one RS485 interface supporting Modbus RTU protocol. Connection of the RS485 bus to the device is on the separate terminal by two wires A and B. Shielding is not required.

i Note

PLA34 does not have built-in termination resistor. If the instrument is at the end of the RS485 bus it should be terminated by 120 Ω resistor.

RS485 interface is fully galvanic insulated from the supply circuits and measuring circuits.

7.7. Ethernet

Instrument is equipped by Ethernet interface 10/100Mbit/s with RJ45 connector. For connection use the cable CAT5 type.

The configuration of Ethernet is defined by the network administrator and have to be set on the PLA34 correspondingly. See chapter 8.2.

Important

If the network configuration is not known, the Ethernet cable should not be plugged into the device.

7.7.1. Connection of PLA34 into LAN

Make a connection to the active network item (Switch, Hub, Router) via UTP cable.

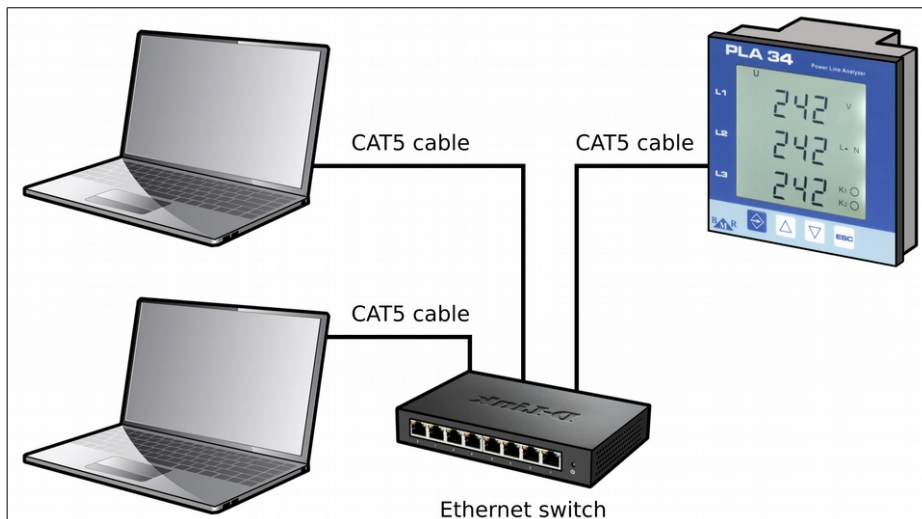

i Note

PLA34 does not support the DHCP. Instrument IP address has to be configured manually at the instrument side.

7.7.2. Connection of PLA34 to WiFi

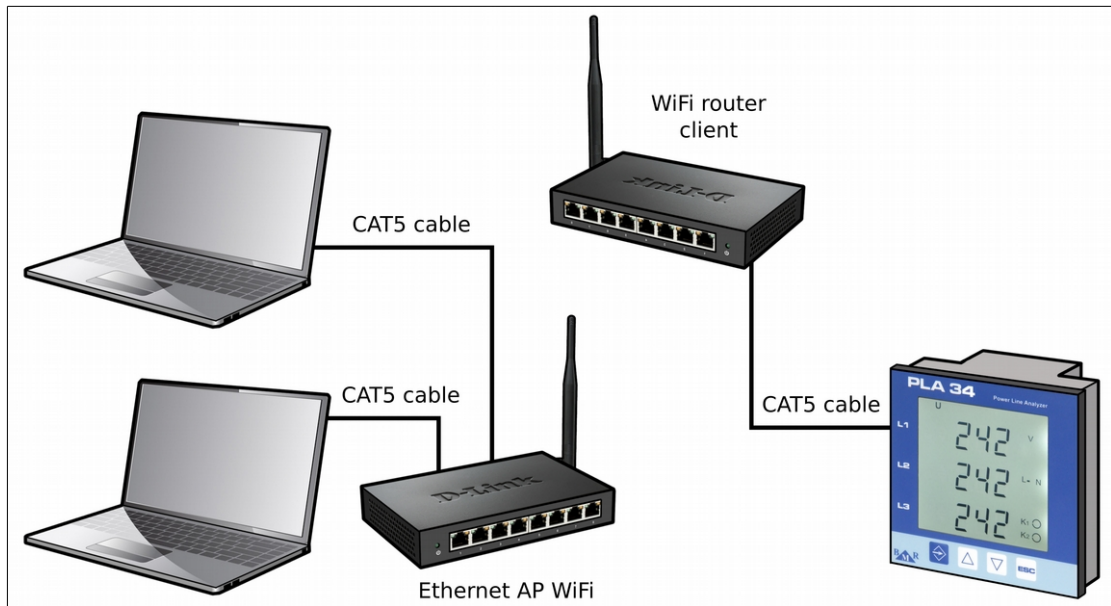

7.7.3. Connection of PLA34 to LAN with NAT server

If there is request for remote access (from Internet) to PLA34, which is place in the local network behind the router with active NAT server, the following parameters configuration to be defined on the router.

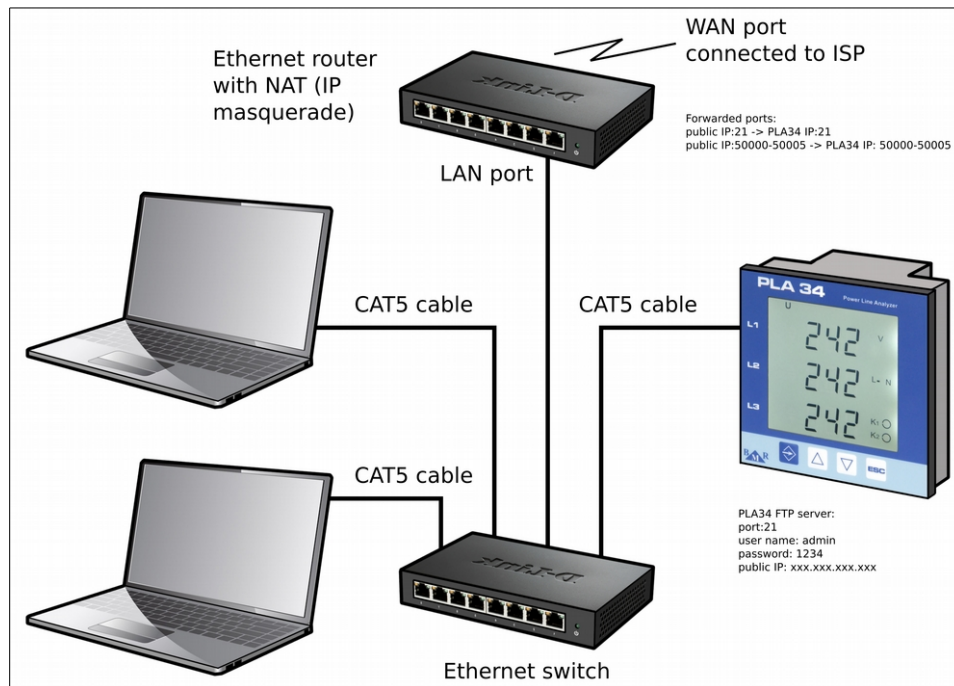

For access to web server of PLA34 there has to be created port forwarding (virtual server):

- router public IP address:port 80 --> IP address of PLA34:port 80

For access to FTP server of PLA34 (needed for PMS software) there has to be created port forwarding (virtual server):

- router public IP address:port 21 --> IP of PLA34 :port 21
- router public IP address:port 50000...50005 --> IP of PLA34:port 50000...50005



Notice

Number of port of 80, 21 is possible change on router. Range of ports 50000 ... 50005 is fixed and it is not possible to change it.

On the PLA34 device it is necessary set following parameters in:

- IP - public
- FTP: 21 (factory value)
- user name: admin (factory value)
- password: 1234 (factory value)



Notice

For communication with FTP server of PLA34 within local network is IP-public parameter set on the same as IP of the device. For communication with FTP server of PLA34 from the internet is the IP-public parameter set on public IP obtained from Internet provider.

7.8. USB

Device has one USB interface of type B for direct connection of PLA34 to the PC. After connection of PLA34 via USB cable to the PC it is necessary select correct communication interface at PMS software.

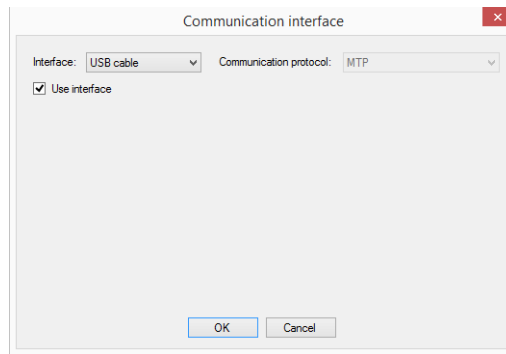

7.9. Digital inputs / outputs

PLA34 is equipped with two optically-isolated transistor outputs inputs. The outputs working mode is fully adjustable as an alarm output, remotely controlled output or pulse output.

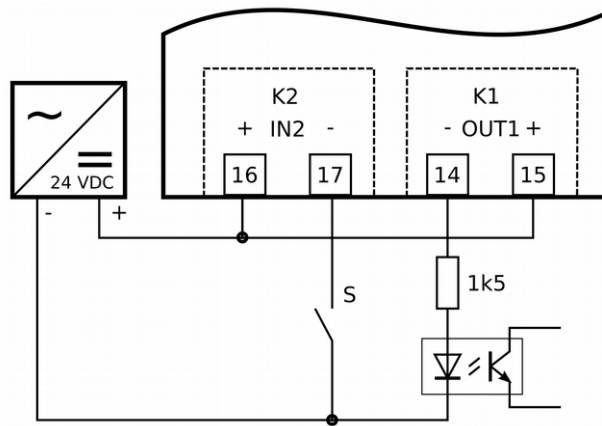

Input / output connection

8. Device settings

Before usage of the PLA34 instrument it is necessary set several parameters essential for correct operation of the instrument in the different type of installations.

PLA34 device can be configured from panel screen for most of the essential parameters. Configuration menu is divided to the two sub-menus for device fundamental settings and menu for communication interfaces settings. Enter the configuration menu by pressing the button **SET** for at least 5 seconds.

For moving in the menu use cursor keys **▲** and **▼**. Key **▲** is normally used for circle moving in the menu. Parameters setting is activated by pressing the key **SET**. Changing the parameter setting is done by cursor keys **▲** and **▼**, confirmation of newly set parameter value by key **SET**. Key **ESC** cancels setting or move back to higher menu or back to normal operation.

Most of the device parameter and functions can be enabled and configured only by PC and software PMS.

8.1. Menu P1

Menu of fundamental settings of instrument such as transformers ratio, display behaviour and internal clock.

Parameter	Description	Factory setting	Setting range
bcl	Device display backlight		
Utr	Voltage measuring transformer ratio		
Itr	Current measuring transformer ratio		
Y, M, d	Calendar settings (Y – year, M – month, d – day)		
H, M	Internal clock setting (H – hours, M - minutes)		
PAS	Instrument password settings	----	0001 ... 9999
rES	Device configuration reset to the factory settings		

Important

*For the instrument variant PLA34RGP set the **Itr** parameter on the same measuring range as DIP switch on rear side of the instrument. The setting as **Itr** parameter can be done performed via Power Monitoring Software.*

8.2. Menu P2

Settings related to the communication interfaces of instrument.

Parameter	Description	Factory settings	Settings range
IP	PLA34 IP address in the local network	192.168.001.201	
MAS	Mask of the Ethernet network	255.255.255.0	
GAt	IP address of PC or router used as a gateway to parent network	192.168.001.001	
PIp	Public IP address of router	192.168.001.001	
Id	Unique identification number in RS485 network	0	0 ... 255
bd	Communication speed of RS485 interface is adjustable in speed	9.6 kBd	9.6 kBd ... 115 kBd
PAr	RS485 interface parity	odd	odd / even
St	RS485 interface stop-bit	1	1 / 2

9. Advanced setting from PMS software

PLA34 instrument itself offers fundamental setting since the display capabilities are limited for an advanced setting.

9.1. Main parameters

Setting “Main parameters” gathers all settings related to measuring circuits connection type, measuring transformers and type of parameters calculation.

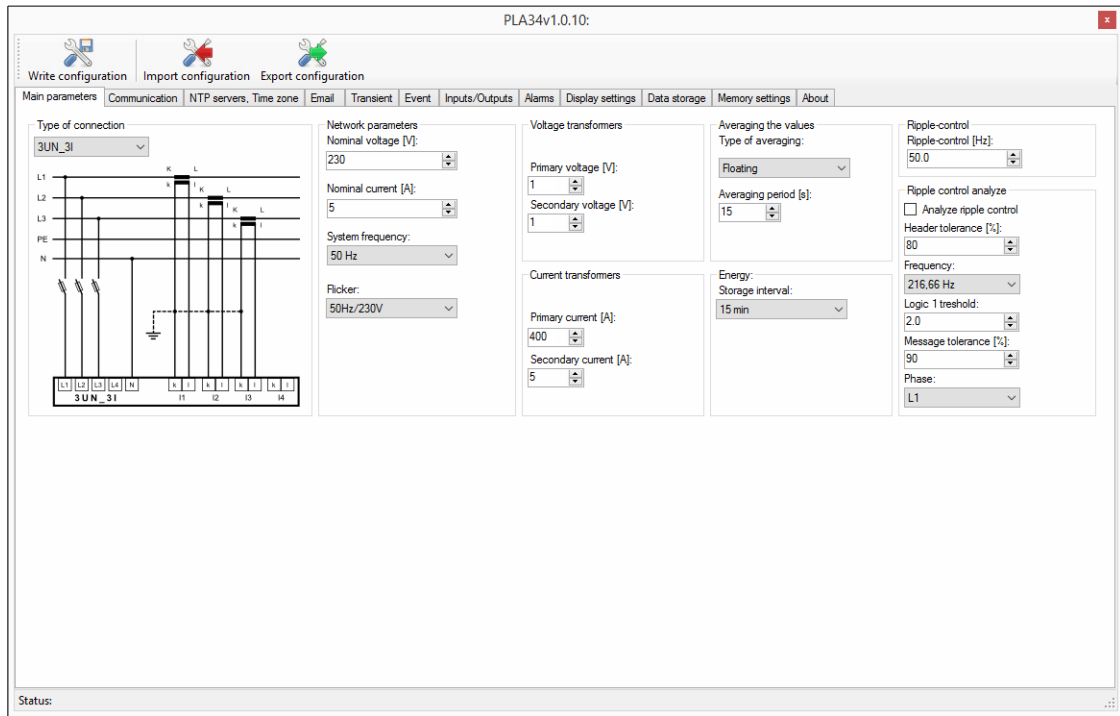

Parameter	Description	Factory settings	Settings range
Type of connection	Defines the type of network and measuring circuit connection	3UN_4I	Chapter 9.1.1
Nominal voltage	Network nominal phase voltage	230 V	1V ... 750 kV
Nominal current	Network nominal phase current	5 A	1A ... 750 kA
System frequency	Defines the nominal system frequency	50 Hz	45 ... 75 Hz
Flicker	Parameter of the nominal voltage and frequency for flicker calculation	230V - 50Hz	120/230V, 50/60Hz
Voltage transformer ratio	Enable the usage of measuring voltage transformer	No	No / Yes
Primary voltage	Primary voltage of measuring voltage transformer in case of its usage	230V	1 ... 750 kV
Secondary voltage	Secondary voltage of measuring voltage transformer in case of its usage	230V	1 ... 750 kV
Current transformer ratio	Enable the usage of measuring current transformer	No	No / Yes
Primary current	Primary current of measuring current transformer in case of its usage	1A	1 ... 750 kA
Secondary current	Secondary current of measuring current transformer in case of its usage	1A	1 / 5 A
Type of averaging	Type of averaging method	Static	Static / Sliding
Averaging period	Time for averaging period setting	5s	1 ... 3600s
Storage interval	Interval of energy meters profile	15 min	15, 30, 45, 60 min
Ripple -control	Adjustable by PMS	50 Hz	50 Hz ... 3 kHz

9.1.1. Network type

PLA34 is designed for various connections according to the grid type or measurement needs. Network settings defines the types network system in which the PLA34 is connected. The main connection diagram of PLA34 is shown in chapter 7. In the following table are shown all possible connection variants that can be defined in the device menu.

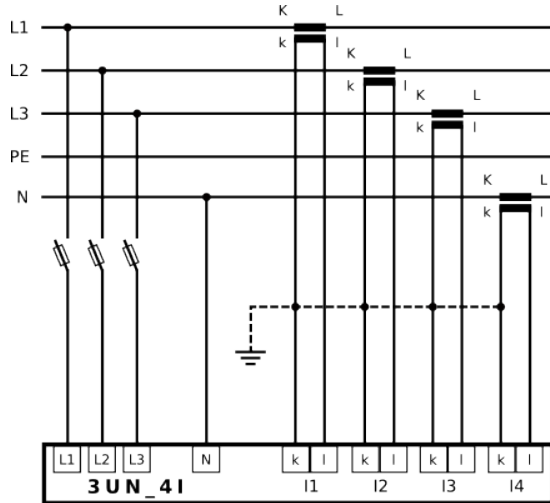

Connection for asymmetric loads in TN-C-S grids

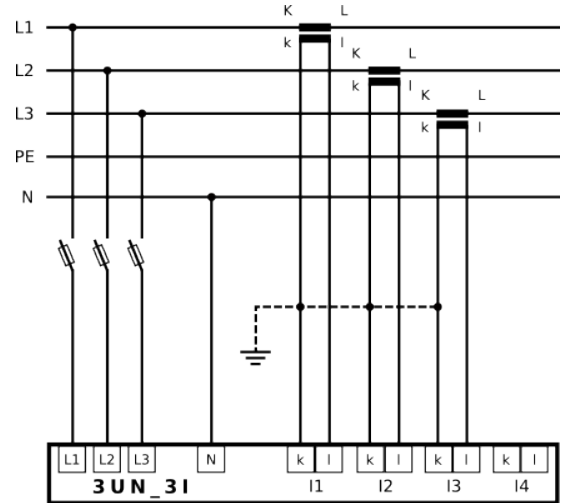

Connection for asymmetric loads in TN-C or TN-C-S

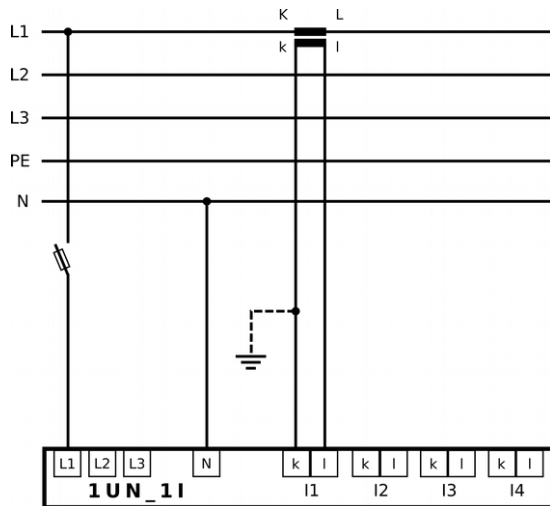

Connection for single-phase loads

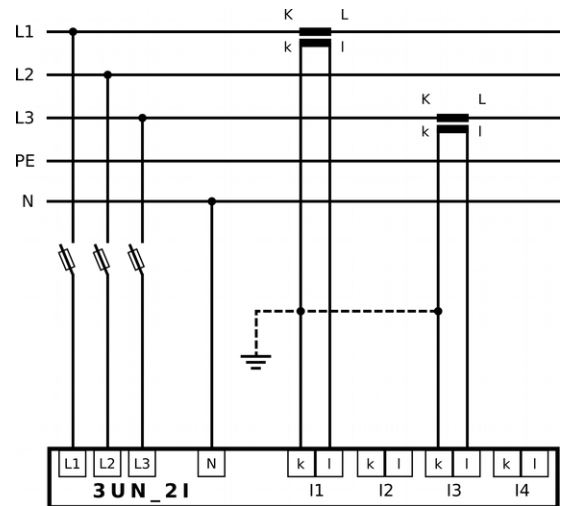

Connection for symmetric loads with two CT only

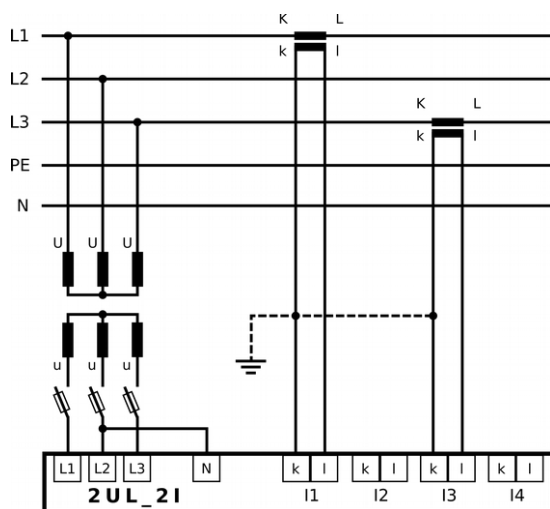

Connection for MV grid (Aron connection)

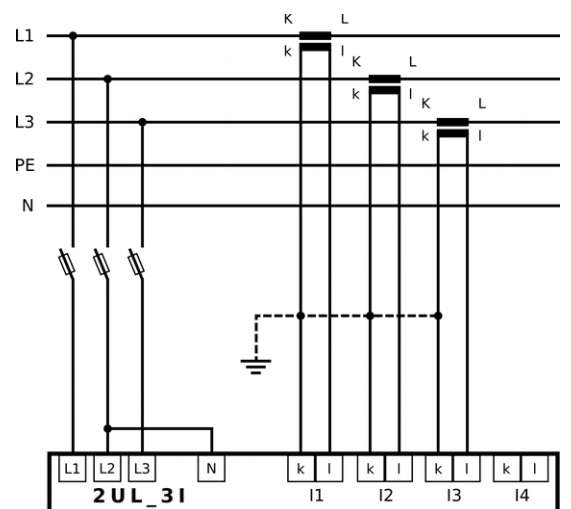

Connection for IT networks

9.1.2. Nominal voltage

Nominal voltage setting is fundamental setting used for capturing thresholds of voltage events and transients. Appropriate value of phase nominal voltage has to be set.

9.1.3. Nominal current

Nominal current setting is fundamental value setting used for threshold calculation for current events.

9.1.4. System frequency

PLA34 is designed for measurement in the 50 Hz and 60 Hz networks. Select the right system frequency for correct sampling of measured voltages and currents.

9.1.5. Flicker

PLA34 calculates flicker according to the norm EN 61000-4-15. It provides values for short-term flicker (10 minutes), long-term flicker (2 hours). For correct calculation of both flickers it is necessary set correct nominal values used in the country standards. Available settings are:

- 230 V – 50 Hz
- 230 V – 60 Hz
- 120 V – 50 Hz
- 120 V – 60 Hz

9.1.6. Ripple control

Ripple control offers feature that provides information about effective voltage value for particular harmonic frequency of measured signal. The frequency of ripple control is adjustable from 50 Hz till 3000 Hz with decimal setting option.

9.1.7. Voltage transformers

If the voltage measuring transformers are used the settings of primary and secondary voltage has to be configured. Both voltage levels (primary and secondary) are set in volts.

9.1.8. Current transformers

PLA34 instrument has 4 current inputs for indirect measurement via current transformers with secondary current 5A or 1A. In case of measuring current transformer usage the primary and secondary current value of CT has to be set.

9.1.9. Rogowski coil measuring range

PLA34RG is an instrument with current measuring inputs designed for connection of Rogowski coils. Instead of current transformer ratio the current measuring range is set. The sensitivity of Rogowski coil allows the wide range setting from 10 A till 10 kA.

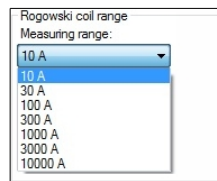

i Note

For correct current measurement check that the DIP switch of current measuring range of Rogowski coil is set on the same value as setting in PLA34RG configuration. For more information see the chapter 7.5

9.1.10. Averaging

This setting defines type of averaging and period of average values calculation. Average values are available on the display of an instrument and in Power Monitoring Software.

There are two types of averaging method:

- **Static window** method cumulates measured values over the defined period. After the period ends the average values are calculated and shown. Cumulated values are erased and new period is measured again.
- **Sliding window** method continually cumulates measured values over the defined period and over this period shows calculated average values. While the time is moving the oldest values are erased and new values added.

9.1.11. Energy

Provides setting of recording interval for historical values of energy counters available in PLA34.

9.2. Communication settings

Instrument is equipped by one Ethernet interface 10/100Mbit/s and RS485. In the PMS software, settings of all available communication interfaces are grouped in cart called “Communication”.

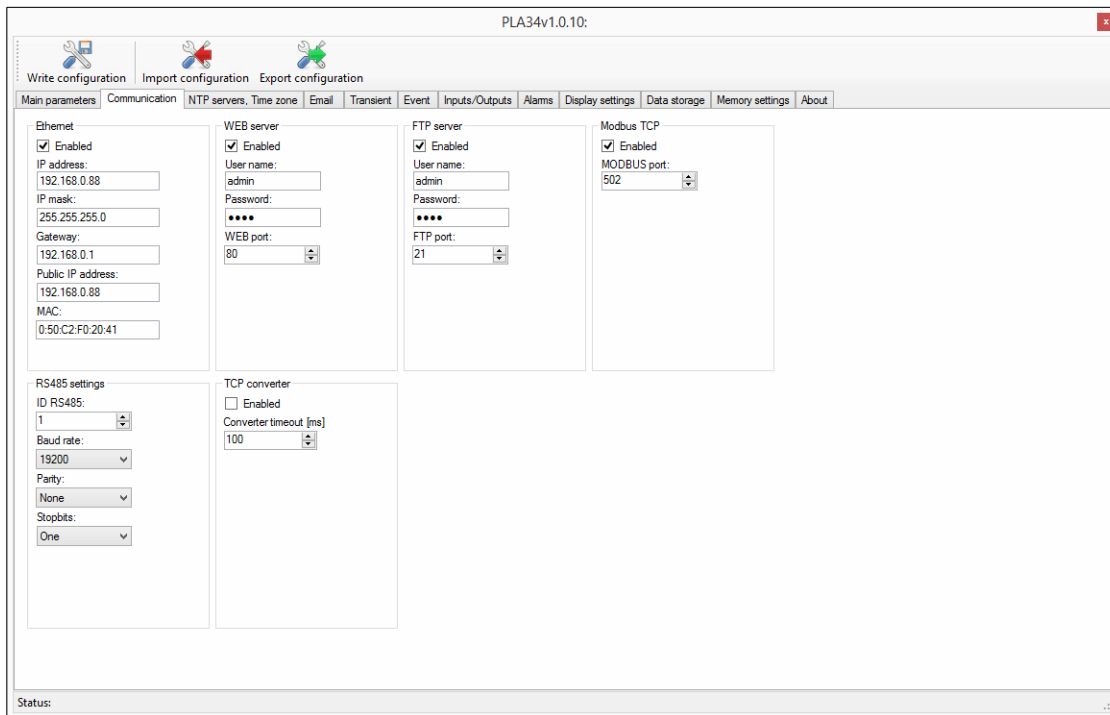

9.2.1. Ethernet

Defines the configuration of Ethernet interface of instrument for visibility and accessibility on LAN and Internet.

Parameter	Description	Factory setting	Setting range
IP address	PLA34 IP address in the local network	192.168.001.201	
IP Mask	Mask of the Ethernet network	255.255.255.0	
Gateway	IP address of PC or router used as a gateway to parent network	192.168.001.001	
Public IP address	Public IP address of router	192.168.001.001	
MAC	Web-server settings advance menu		

Important

Public IP address is necessary to set for these cases when instrument is accessed from different network, for example Internet, while it is located in the Ethernet behind the NAT server.

9.2.2. Web-server

Instrument has build in web-server for remote on-line monitoring via Internet or local network. Following table describes settings related to web server configuration of PLA34.

Parameter	Description	Factory setting	Setting range
WEB server	Activates the internal web server of PLA34	Yes	Yes / No
User name	Web-server user name	admin	
Password	Web-server password	1234	
Web port	Port of web server	80	1 ... 65535



Notice

Web server is optimized for portable instruments such as mobile phones and tablets.

9.2.3. FTP server

FTP server is a fundamental communication protocol for reading the measured data, recorded data and configuration of the instrument. Enabled FTP is server is an essential setting needed for correct work of PLA34 with Power Monitoring Software.

Parameter	Description	Factory setting	Setting range
FTP server	Activates the internal FTP server of PLA34	Yes	Yes / No
User name	FTP server user name	admin	
Password	FTP server password	1234	
FTP port	Port of FTP server	21	1 ... 65535

9.2.4. Modbus TCP

Communication protocol Modbus TCP is used for communication with PLA34 over the Ethernet interface.

Parameter	Description	Factory setting	Setting range
Modbus TCP	Activates the Modbus TCP communication protocol of PLA34	Yes	Yes / No
Modbus port	Port of Modbus TCP communication	502	1 ... 65535



Note

On the request the table of Modbus registers can be provided. Please, contact us on export@bmr-trading.com.

9.2.5. TCP converter

PLA34 is equipped by function of Modbus TCP converter so it can provide access to instruments connected on RS485 bus of PLA34.

Parameter	Description	Factory setting	Setting range
TCP converter	Activates the Modbus TCP converter of PLA34	Yes	Yes / No
Converter timeout	Converter timeout	500 ms	100 ... 5000 ms

Modbus TCP converter function has allowed Modbus user functions so it is suitable for transmission of long data packets such as recorded data from flash memory of PLA33CMB instruments.

9.2.6. RS485

Serial port RS485 configuration is essential for the usage of PLA34 as a TCP/IP converter.

Parameter	Description	Factory setting	Setting range
ID	Unique identification number in RS485 network	0	0 ... 255
Transfer rate	Communication speed of RS485 interface is adjustable in speed	9.6 kBd	9.6 kBd ... 115 kBd
Parity	RS485 interface parity	odd	odd / even
Stop bit	RS485 interface stop-bit	1	1 / 2

9.3. NTP server, Time zone

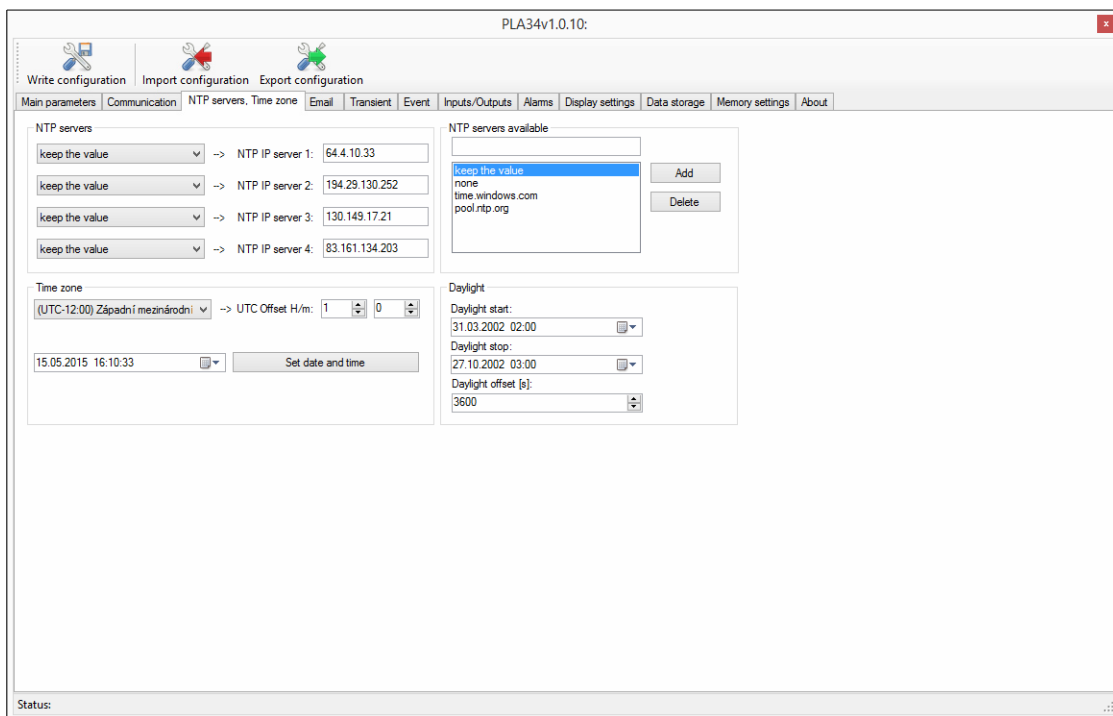

PLA34 corrects internal clock according to NTP servers while it is connected to Internet. NTP time synchronization has always priority above the manual clock settings. Clock synchronization by NTP is fully automatic and there is no need to set anything.

The selection of closest NTP server is adjustable in software PMS. For the finding the closest NTP server refer to the following link <http://support.ntp.org/bin/view/Servers/StratumOneTimeServers>.

9.4. Email

PLA34 can notice several events and alarms by sending an e-mail up to 4 different e-mail addresses. The email notification setting is available only from Power Monitoring Software.

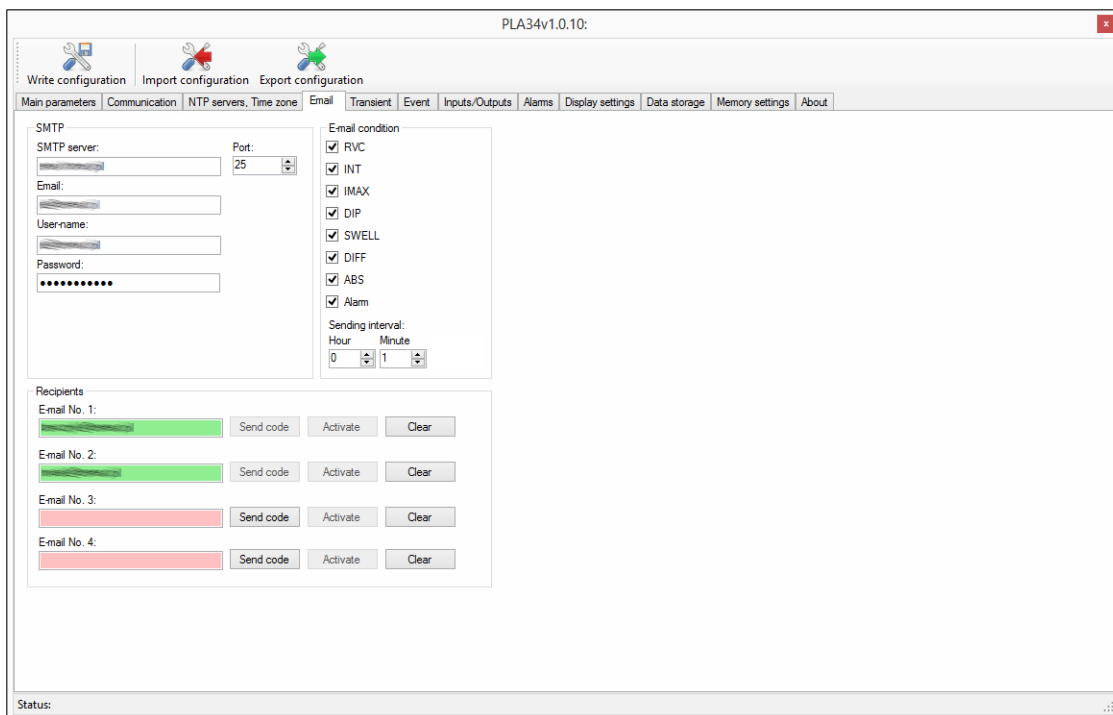

For correct setting obtain the SMTP server address from your provider. If the SMTP server requires authentication enter the

user name and password.

Select the requested e-mail notification and sending interval. Sending interval defines how often the emails are sent in order to prevent

Sending interval defines how often the email is sent. Factory setting is 1 hour which means that all events and alarms that appears during that hour are sent in one email. This interval prevents the instrument to send too many e-mails.

For most recent 5 events and transients the graphs are sent in the e-mail too. Other events and transients are shown as a recording in table.

9.5. Transient

Voltage transients are short commutation, impulse or oscillatory events in electrical grid. Their source can be inductive load switching, power factor correction instruments, atmospheric events, protection instruments action or malfunction of switching elements in the grid.

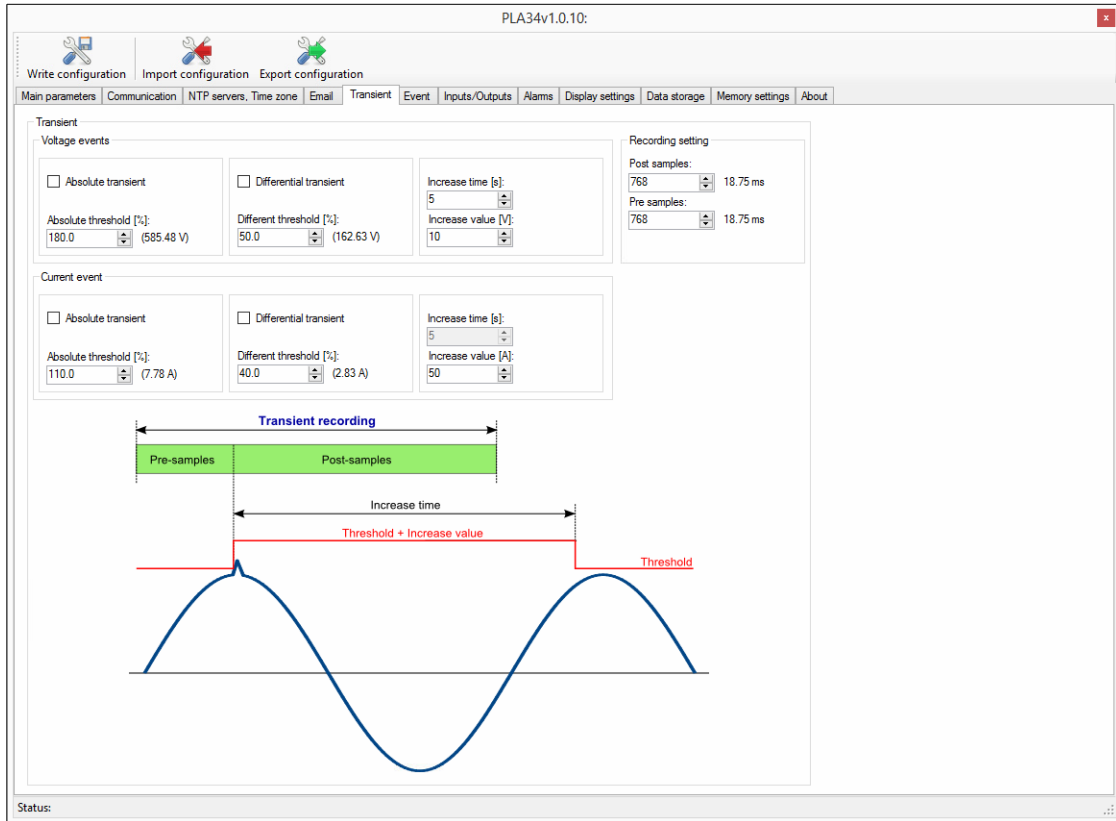

PLA34 analyser detects two types of transients. Absolute transients and differential transients.

- **Absolute transients** are detected according to override of defined voltage level. The trigger for detection of the absolute transients is defined by absolute threshold (percentage of U_{din}).
- **Differential transients** are detected according to the difference between two consecutive voltage measurements. The difference between measurement is defined by differential threshold (percentage of U_{din}).

Common settings for absolute and differential transients is for the parameters used for tuning the transients detection and transients recording.

If the transient is detected and being recorded the instrument increase the absolute and differential thresholds to prevent of misled transient detection. It prevents instrument against wrong recordings. This is defined by two user adjustable parameters. Increase value and increase time.

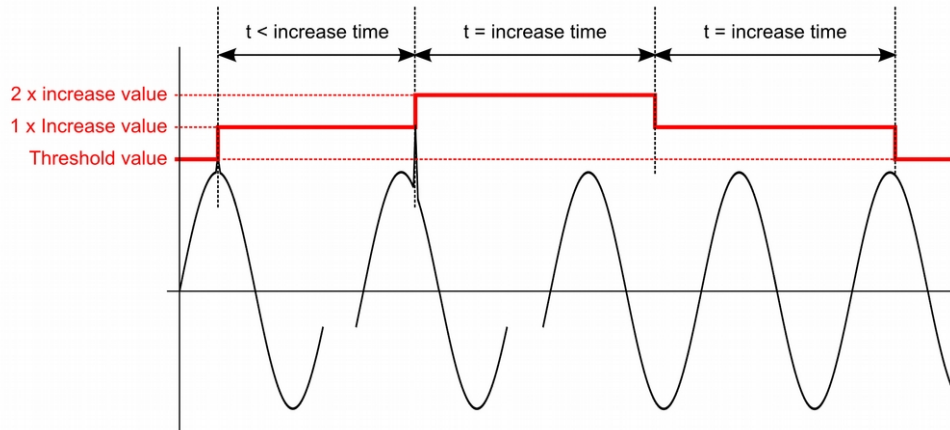

- Increase value is the value that is used for increasing the absolute and differential threshold while transient is detected. Set value increase the threshold level for the defined time.
- Increase time is a time delay for which the increased value of threshold is valid. After the increase time expires the value of threshold is returned back the user set value.

If another transient appears while the increase time is still not expired the threshold is increased once again. After the increased time expires the threshold is recovered to the previous level and after another period of increase time it is threshold recovered to the user defined level of absolute and differential thresholds.

Parameter	Description	Factory setting	Setting range
Absolute transient	Absolute transient activation	No	YES / NO
Absolute threshold	Threshold absolute transient setting	110%	100 ... 500%
Difference transient	Difference transient activation	No	YES / NO
Difference threshold	Threshold difference transient setting	20%	1 ... 100%
Increase time	Time delay before next transient recording after transient start	5s	1 ... 20 s
Increase value	Increment value for transient insensitivity after recording start	10V	1 ... 750000 V
Post samples	Number of recorded samples after the transient start	768	0 ... 8000
Pre samples	Number of recorded samples before the transient start	768	0 ... 8000

Memory space for capturing of the particular transients is fixed on the maximum of 8000 samples. Definition of number Pre and Post samples is limited by this maximum samples memory space.

9.6. Events

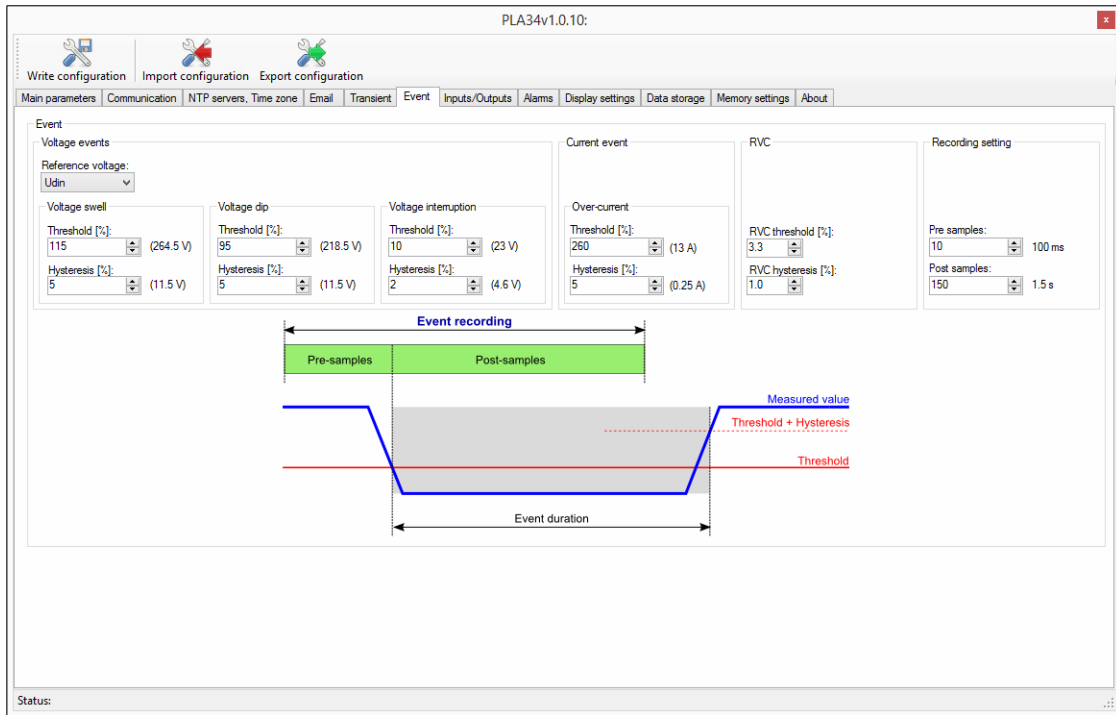

Events captured by PLA34 are fully adjustable by the parameters described in the table beneath.

Parameter	Description	Factory setting	Setting range
Reference	Reference voltage level type	Udin	Udin / Sliding
Over-voltage	Threshold	110%	100 ... 500%
	Hysteresis	5%	1 ... 20%
Under-voltage	Threshold	90%	1 ... 100%
	Hysteresis	5%	1 ... 20%
Interruption	Threshold	5%	1 ... 100%
	Hysteresis	2%	1 ... 20%
Over-current	Threshold	110%	100 ... 500%
	Hysteresis	5%	1 ... 20%
Pre Samples	Number of recorded half periods Urms1/2 (10ms = 1) before event	10	0 ... 4000
Post Samples	Number of recorded half periods Urms1/2 (10ms = 1) after event	150	0 ... 4000

Memory for capturing the samples of RMS curve is fixed on the maximum of 4000 samples. Definition of number Pre and Post samples is limited by this maximum samples memory space.

9.6.1. Voltage dip detection

The dip threshold is a percentage of either U_{din} or the sliding voltage reference. The user shall declare the reference voltage in use.

- On single-phase systems a voltage dip begins when the Urms voltage falls below the dip threshold, and ends when the Urms voltage is equal to or above the dip threshold plus the hysteresis voltage.
- On poly-phase systems a dip begins when the Urms voltage of one or more channels is below the dip threshold and ends when the Urms voltage on all measured channels is equal to or above the dip threshold plus the hysteresis voltage.

The dip threshold and the hysteresis voltage are both set by the user according to the use.

9.6.2. Voltage swell detection

The swell threshold is a percentage of either U_{din} or the sliding reference voltage. The user shall declare the reference voltage in use.

- On single-phase systems a swell begins when the Urms voltage rises above the swell threshold, and ends when the Urms voltage is equal to or below the swell threshold minus the hysteresis voltage.

- On poly-phase systems a swell begins when the Urms voltage of one or more channels is above the swell threshold and ends when the Urms voltage on all measured channels is equal to or below the swell threshold minus the hysteresis voltage.

The swell threshold and the hysteresis voltage are both set by the user according to the use.

9.6.3. RVC

A Rapid Voltage Change (RVC) is an event characterized by a quick transition from one steady-state voltage to another. Typically, RVC events are counted for a period of one hour, or for each day. Mains signalling voltage, called “ripple control signal” in certain applications, is a burst of signals, often applied at a non-harmonic frequency, that remotely control industrial equipment, revenue meters, and other devices.

If the change in voltage is sufficient to cross the dip threshold or the swell threshold, then the event shall not be recorded as an RVC event. It is a dip or a swell.

The RVC threshold (or thresholds) and the RVC hysteresis are both set by the user according to the use. The RVC threshold is a percentage of U_{din}. The RVC hysteresis is a smaller percentage of U_{din}.



NOTE

Although RVC and Flicker both may cause changes in illumination levels that irritate people, the two are different in concept. RVC is a discrete event, while flicker is a quasi-stationary condition.

Parameter	Description	Factory setting	Setting range
RVC threshold	The RVC threshold is a percentage of U _{din}	3.3%	1 ... 100%
RVC hysteresis	The RVC hysteresis is a smaller percentage of U _{din}	1%	1 ... 20%

According to the norm the ideal settings is RVC threshold on 3.5% of U_{din} and hysteresis on 1% of U_{din}.

9.7. Inputs/Outputs

Analyser PLA34 has two user configurable inputs/outputs. Connection of the inputs and outputs is displayed in the chapter 7.9.

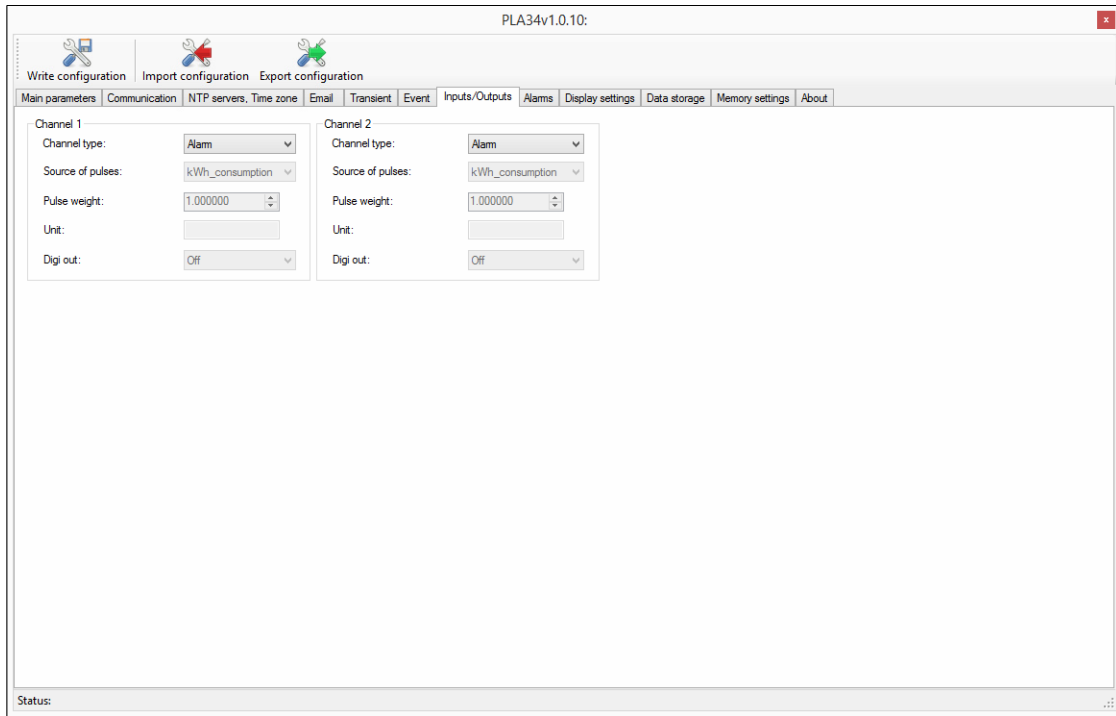

Parameter	Description	Factory setting	Setting range
Channel type	Defines the usage of the input and output interface	Digi_in	Digi_in / Digi_out / Pulse_in / Pulse_out / Alarm
Source of pulses	Setting available only for Pulse_out channel type		
Pulse weight	Setting available only for Pulse_out and Pulse_in channel type	0	
Unit	Setting available only for Pulse_in channel type. Defines the unit of pulses		
Digi out	Available only for Digi_out channel type. Defines fundamental state of output.	Off	On / Off

9.8. Alarms

Instrument is equipped by two input / output terminals which can be programmed to the four different states. Terminal one or two can be set to work as an alarm output.

Each output, while it is set to behave as an alarm, consists from three comparators. Comparators are sorted into logical function according to following diagram.

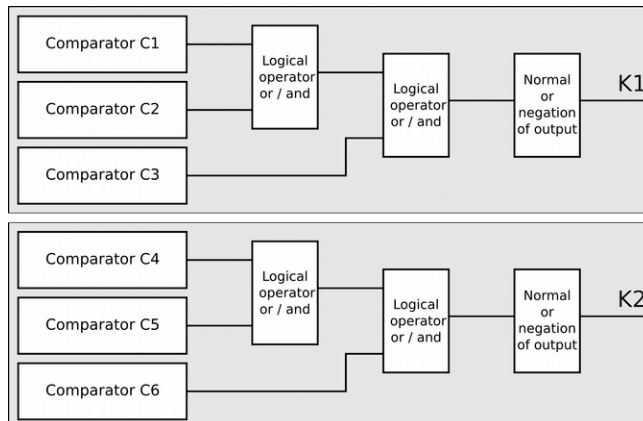

Comparators C1, C2 and C3 belong to the output K1 and comparators C4, C5 and C6 to output K2. From the picture is visible that there are logical function between first two comparators of the group and between their result and last comparator of the group. There are two logical operators available, logical conjunction – AND and logical disjunction – OR.

Each comparator has several available settings.

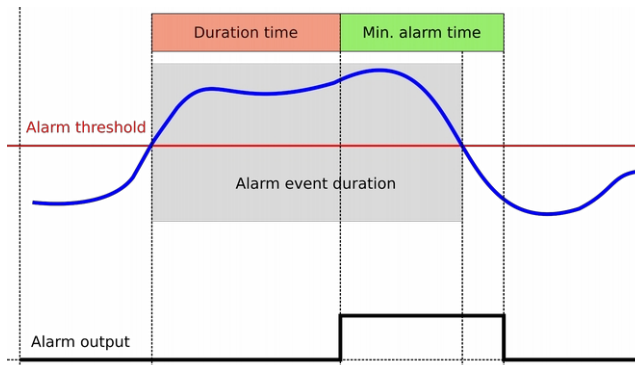

- Measured parameter – controlled parameter for an alarm
- Value – alarm threshold value of controlled parameter
- Relation – comparator type (<, >)
- Duration – duration time of an alarm event before the output reaction
- Min. time – minimum output reaction time

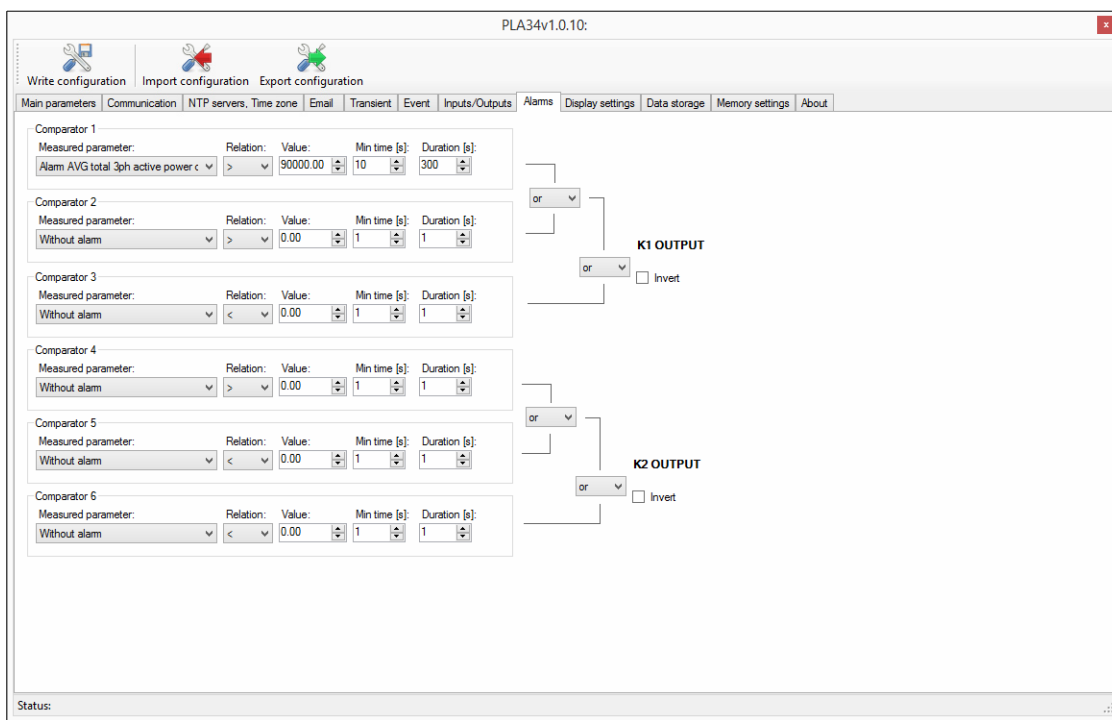

Important

For correct work of an alarm it is necessary set the instrument outputs to behave as an alarm outputs. See the chapter 9.7. Proper connection of outputs is described in chapter 7.9.

9.9. Display settings

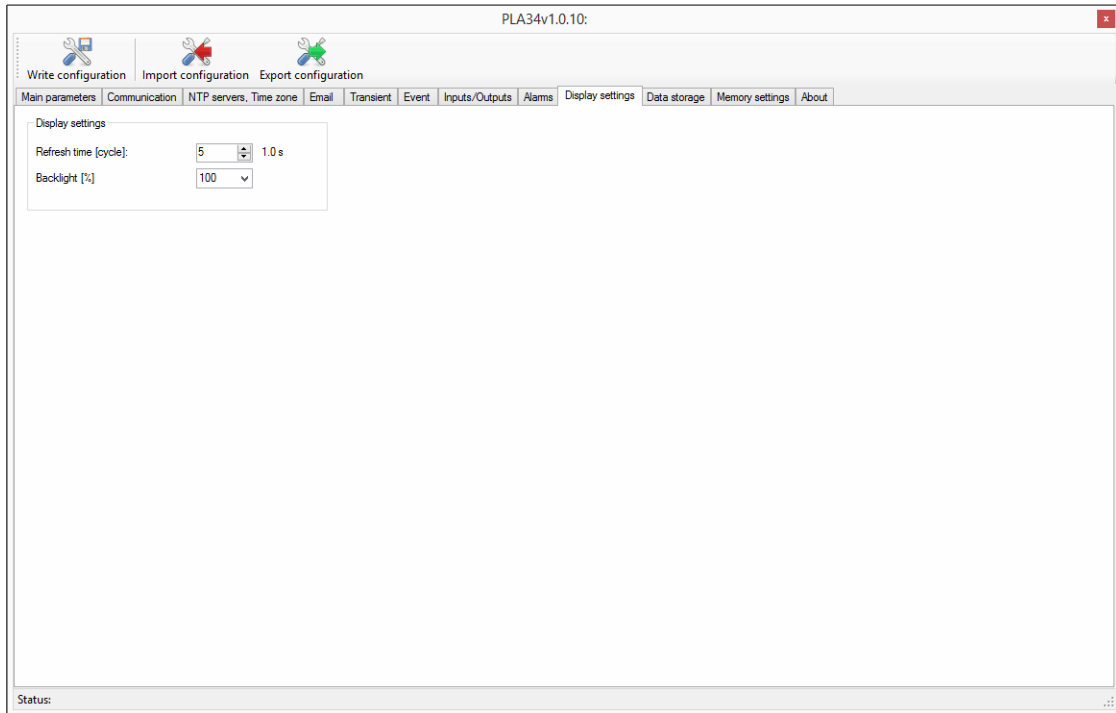

Parameter	Description	Factory setting	Setting range
Refresh time [cycle]	Refresh time of the displayed values.	5	1... 50
Backlight [%]	Backlight intensity of instrument LCD display.	50	0 ... 100

Without any action on keyboard of an instrument the device backlight will turn off in 120s.

It is possible to set permanent ON of the display backlight. This case the backlight will light on 50%. Permanent OFF keeps the backlight with 5%.

9.10. Data storage

Measured parameters can be recorded in the internal flash memory. For this purposes cart Data storage offers the list of all parameters that can be stored. PLA34 allows to define 5 different intervals with adjustable time of interval and list of recorded parameters.

List of recorded parameters of all intervals can be saved as a template for further usage. There is also predefined template according the power quality norm EN50160.

9.11. Memory settings

Memory of the PLA34 is possible be managed to obtain more space for preferred recordings. Simple move of particular memory are borders modify the size of available space.

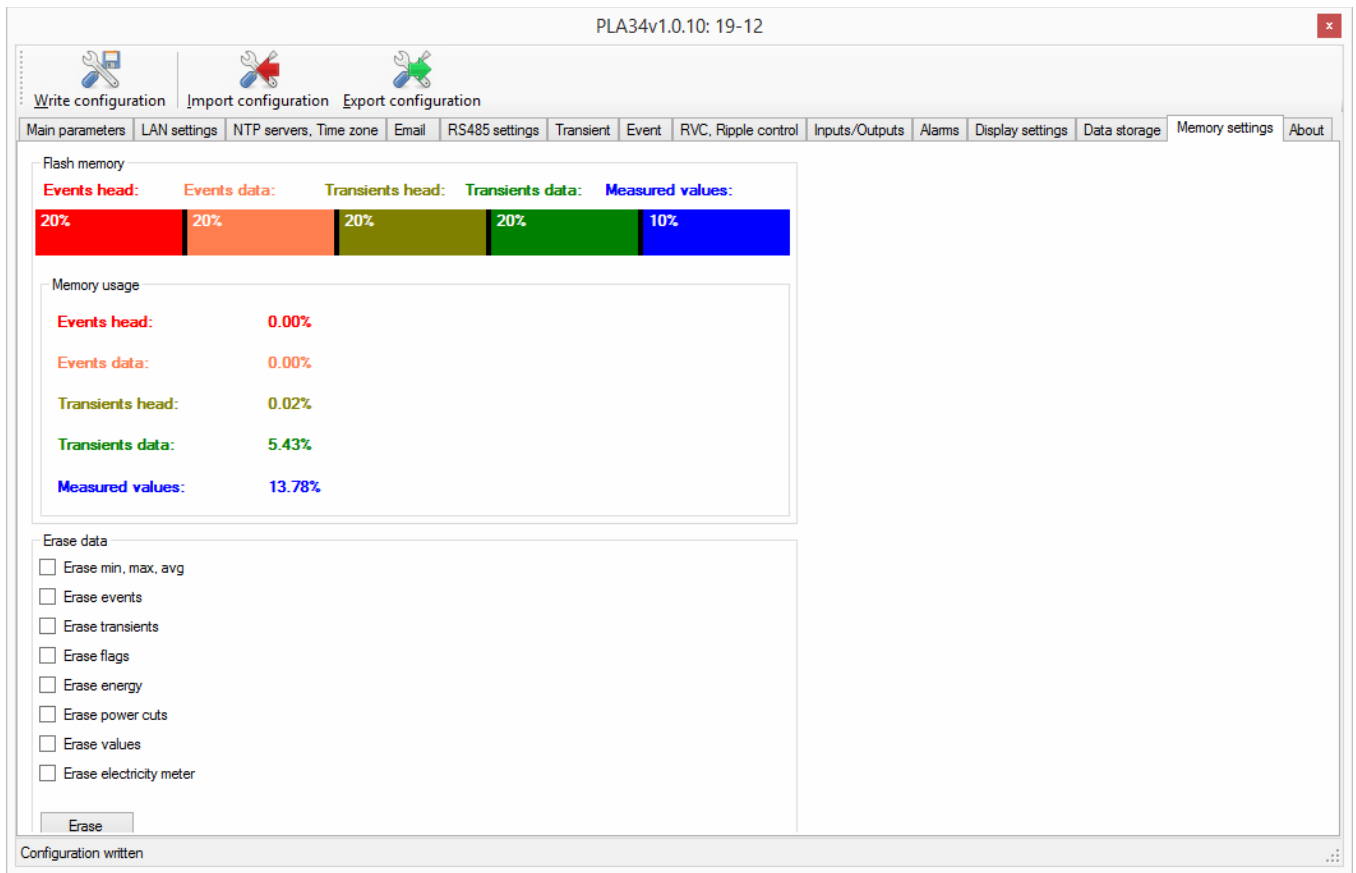

9.12. About

Information about the vendor and device firmware version.

10. Operation

PLA34 allows simple operation of basic screens with most interesting parameters.

For moving in the menu use cursor keys ▲ and ▼. Key ▼ is normally used for circle moving in the one level of screens. Key ▲ moves to another level of screens. Pressing the button SET shows maximums, minimums and average values of displayed parameters. ESC key returns back to first screen.

Full list of measured parameters, events and transients is available via the web server or PC and monitoring software PMS.

10.1. Screens structure

Meaning of each screen is easily identified by usage of standard ISO symbols and value parameters. Every displayed parameter value is shown with its variable.

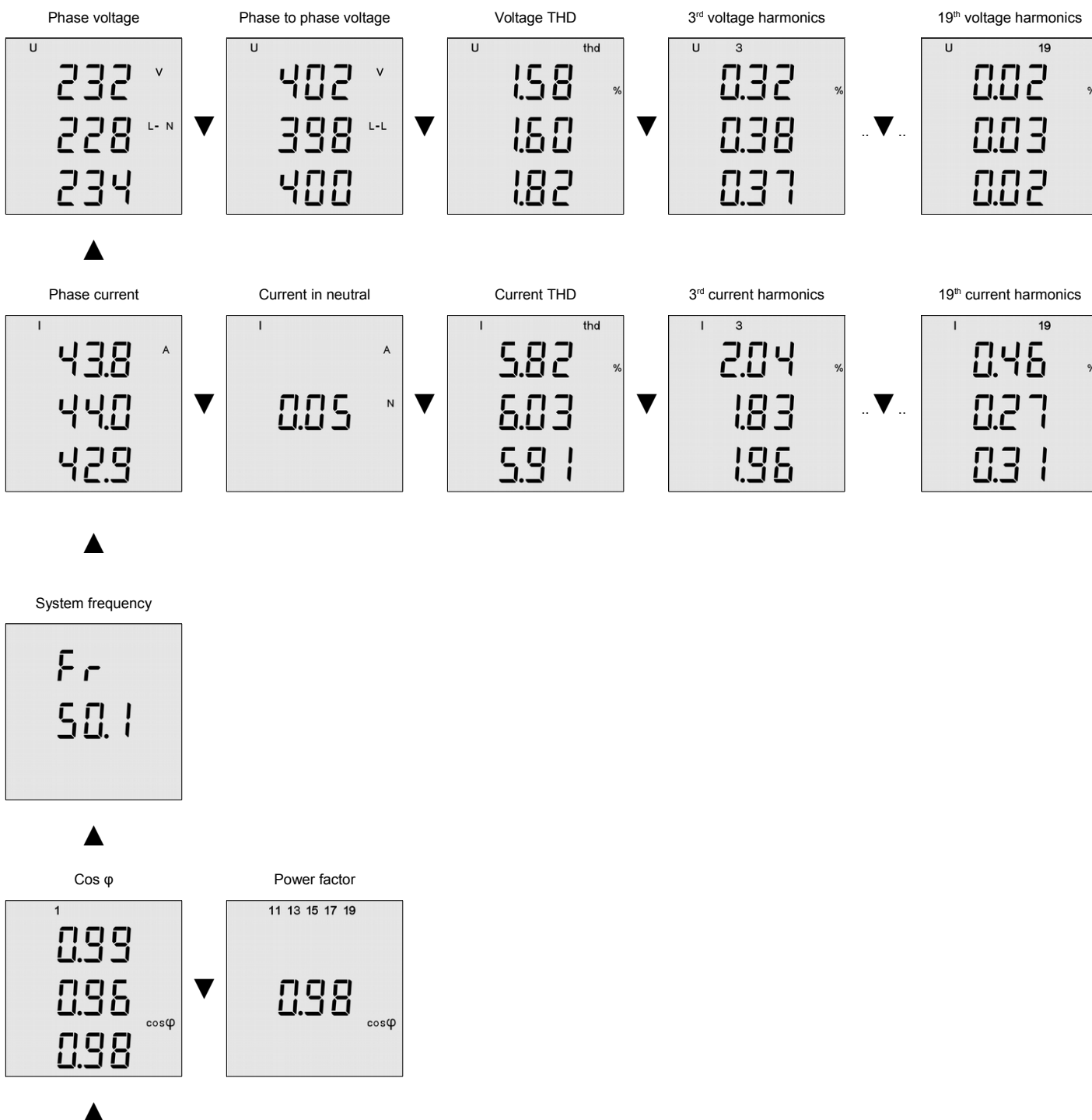

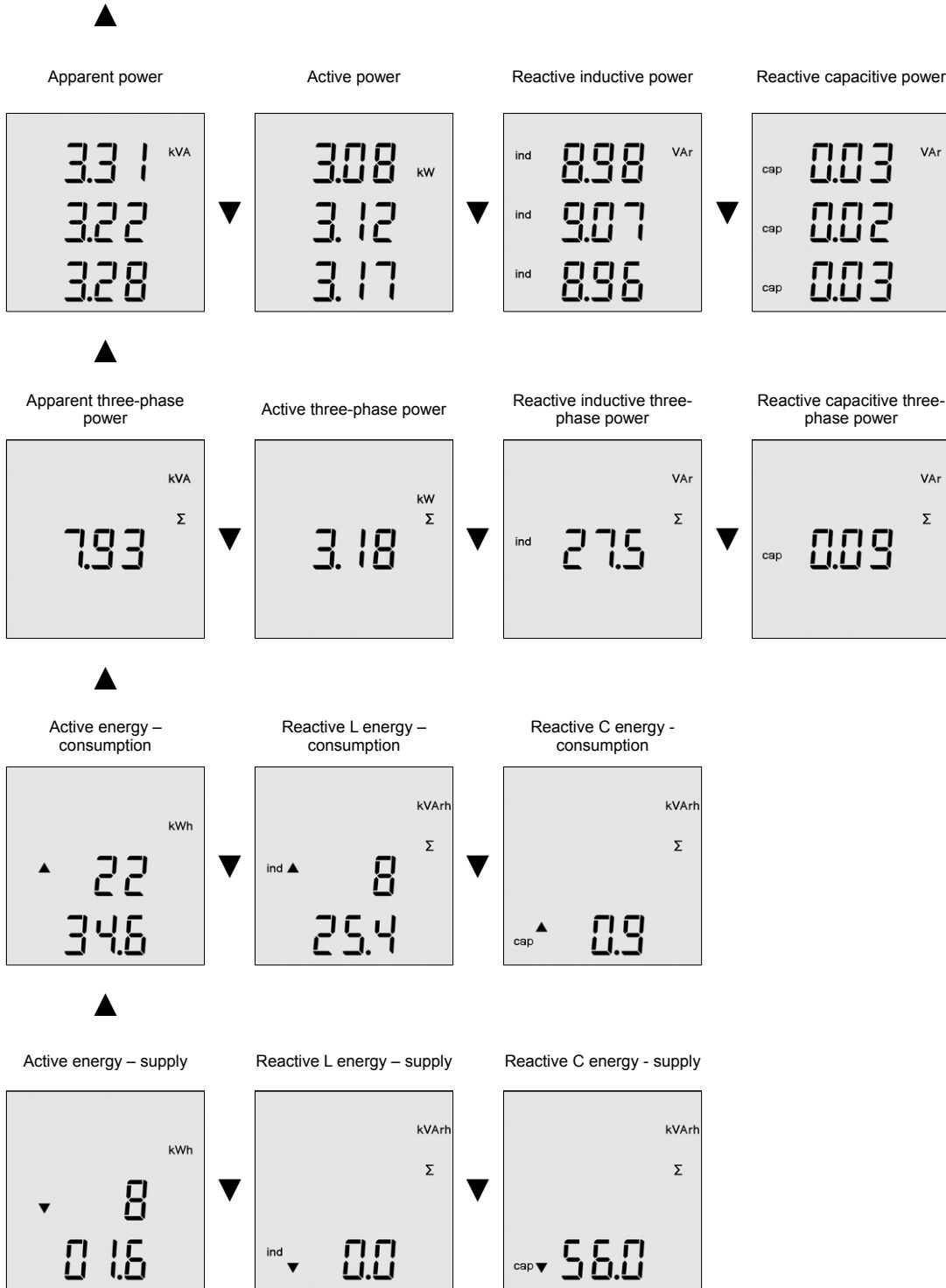

10.2. Max, Min and AVG values

PLA34 shows on the display maximums, minimums and averages of measured values. For presenting the maximum value one short press of key **SET** is needed. Maximum values are symbolized by symbol ▲ before the displayed number. Second short press of key **SET** displays the minimum values if available. Minimum values are symbolized by symbol ▼ before the displayed number. Third short press of key **SET** will turn back to the instantaneous measurement.

For average values displaying press the key **SET** three-times. Average value is introduced by displayed symbols ▲ and ▼ at the same time.

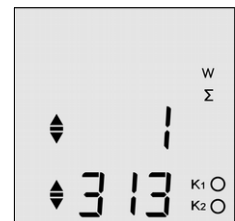
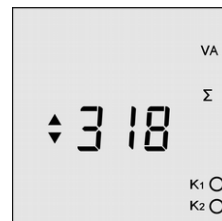

Since the average value of powers is four-quadrant the average value of consumption is introduced only by symbols ▲ and ▼. For distribution the value is introduced by negative sign between symbols ▲ and ▼.

10.3. Output signalization

Outputs can be operated in four states. Signalization on the LCD is common for all of them and differs according to following table.

Parameter	Description	Activated	Deactivated
In	input	K1	K1
Out	output	K1	K1
PuL	pulse output	K1 at pulse presence	K1
AL	alarm output	K1 flashing	

11. Web interface

PLA34 has built in web server to show measured parameters in the internet browsers. For enabling the web server see the chapter 9.2.2. Web server is designed for web browsers compatible with HTML5 specification.

Web server of an instrument is available after setting the instrument IP address to the web browser. Access to the web page is protected by user name and password.

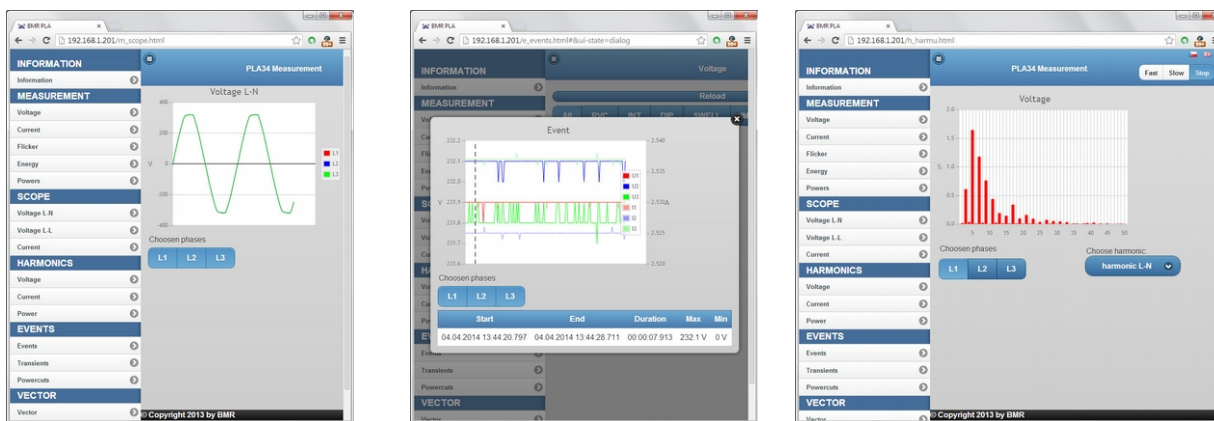

Note

Factory setting of user name is **admin**. Password factory setting is **1234**.

12. Firmware update

Device firmware can be update when the new firmware is released. Visit the www.bmr-trading.com for to verify availability of new firmware. Firmware file is prepared as an exe file that is directly run on Windows PC.

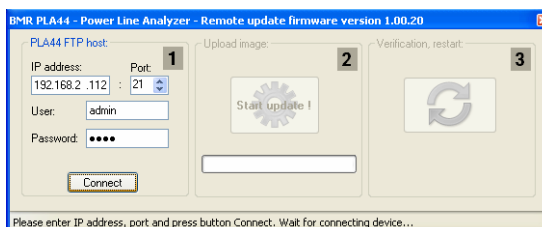

For the successful firmware update connect the PLA34 via Ethernet to PC where the Update software will run. Enter the IP address of the PLA34 and user name and password. Pressing button Connect will verify accessibility of PLA34 and prepare connection for firmware update start.



Important

While firmware is being updated, device should be connected to stable power supply and Ethernet connection should not be removed or interrupted.

13. Technical features

Parameter	Value
Supply voltage	85 ... 265 V _{AC/DC}
Power consumption	< 4 VA
Voltage measuring range L - N	2 ... 600 V _{AC}
Voltage measuring range L - L	4 ... 1000 V _{AC}
Current measuring range	0.001 ... 6 (8.5) A
Frequency measuring range	40 ... 70 Hz
Clock accuracy	< 1 s per day
Number of output / input	2
Output type	NPN transistor free potential optical insulated
Maximum voltage for output usage	24 V _{DC}
Maximum output load capability	100 mA
Input type	optical insulated free potential
Maximum input voltage	24 V _{DC}
Maximum input consumption	10 mA
Voltage transformer ratio	1 ... 750 000
Current transformer ratio	1 ... 750 000
Supply voltage power cuts memory	15 events
Sampling rate	40 kHz
Events trigger	10 ms
Data memory for measured parameters	1 GB
Display type and size	LCD
Communication port	RS485 (optional) / Modbus RTU / 9.6, 19.2, 38.4 ... 115 kBd
Ethernet	RJ45 / 10/100 Mbit
USB	Type B
Over-voltage class	600V CATIII
Pollution degree	2
Temperature limit	-25°C ... +60°C
Front panel dimensions	96 x 96 mm
Panel cutout dimensions	92 x 92 mm
Site depth	75 mm
Weight	525 g
Protection degree	IP20 rear cover / IP54 front panel
Related standards	EN 61000-4-30 class S, EN 61000-4-7, EN 61000-4-15, EN 61557-12